

# VAASA 50W

Code: LCV0526FNS1TG-01

## TECHNICAL SPECIFICATION

Light source	High brightness LED
Color rendering index	> 70
Luminaire luminous flux	4000lm [average]
Power consumption	up to 50W
Power factor	>0.9
Operation temperature	-30°C ~ 50°C
LPW@Tj25°C	80 lm/w (6000K)
Light distribution pattern	as customer requests
Long lifetime LED	> 50,000 hours

### IP Degree

# IP 67

No UV or IR light radiation
Special batwing and bisymmetrical light pattern
Optimized heat fins with artistic design
110V/240V input Voltage



## FEATURE & DIMENSION

Min. 96 mm  
Max. 97 mm

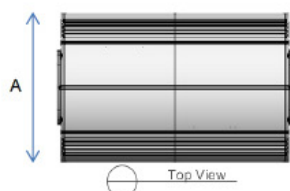
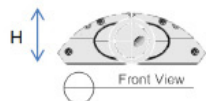

Min. 283 mm  
Max. 284 mm

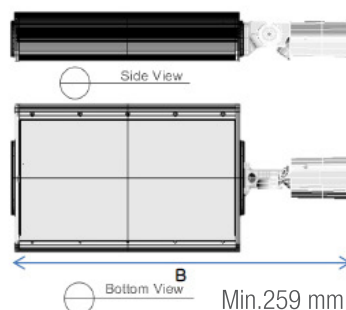

Min. 259 mm  
Max. 261 mm

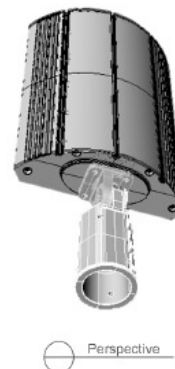

## ARM TYPE

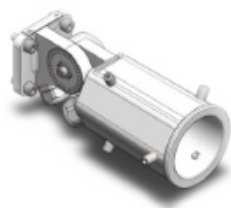

[ APO - 04 - T ]

## PHOTOMETRIC CHARACTERISTIC

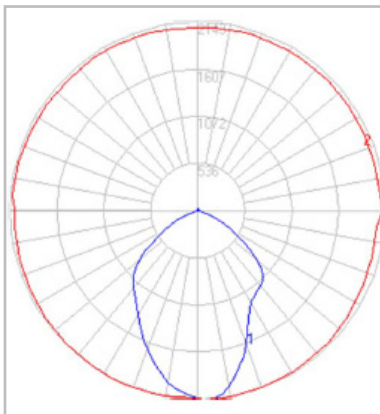

Light distribution pattern

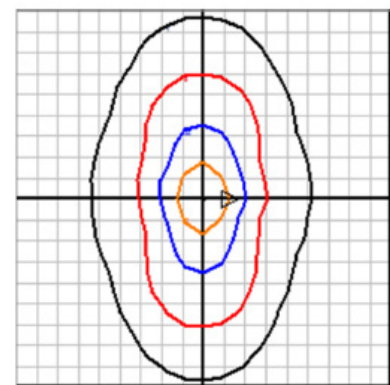

Illuminance iso-line



## APPLICATION



Be replacing the existing light such as sodium lamps(30W, 70W) with LED guard light, Vaasa, 50% energy saving and fivefold increased lifespan are achieved.

### Application

- Public roadways
- City Streets
- Parks
- Walkways
- Car Parks

## PRODUCT NUMBER

LCV 05 36 FN S 1T G - 01

